

90° USB2 A to A keystone coupler

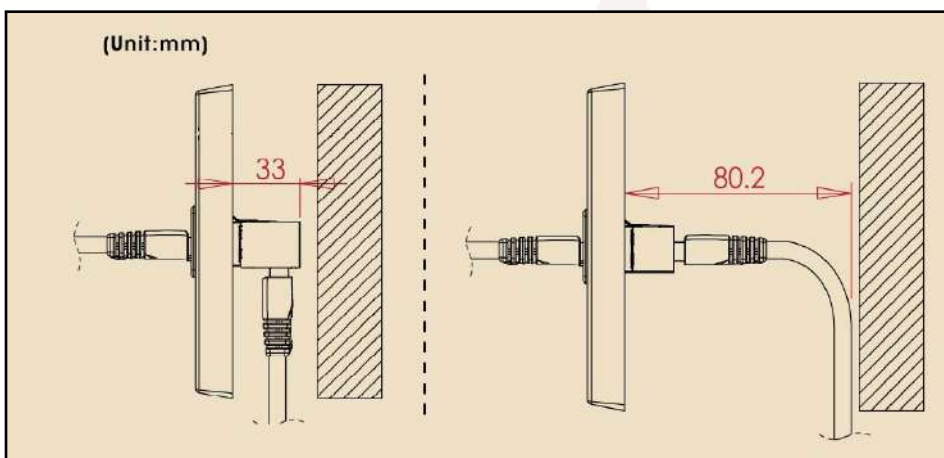

90° USB2 A to A keystone coupler (KCUAA290BK + KCUAA290WH)
High performance USB2 keystone coupler ideal for use in limited space

Features

- Slim and very compact design enables use in panels or faceplates where width or depth are restricted
- USB 2.0 keystone coupler (A type female connectors on the front and back)
- Backwards compatible with USB1.1 type
- Designed to fit industry standard keystone mount outlets wall plates and patch panels

Specifications

- Weight: 9.5g
- Dimensions: 38 x 16.5 x 20.8
- Colour: Black or White
- Material: Housing: ABS UL94V-0
Contact: Copper alloy
Shell: Nickel plated copper alloy
- Connection: USB2.0 A F/F
- USB power connected device 1.5A at 30V

Commodity Code: 85444290

EAN: KCUAA290BK 5055386507471
 KCUAA290WH 5055386507488

Packaging: Individual Poly Bags with instructions. Packed in 20's



ROHS Compliant

**Code: KCUAA290bk
KCUAA290wh**

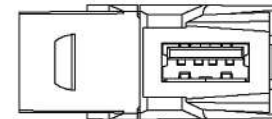
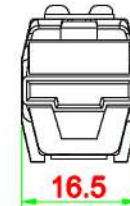
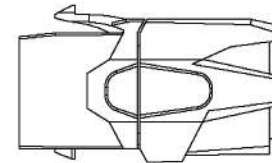
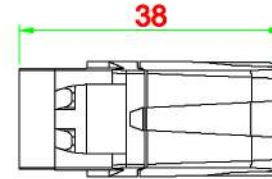
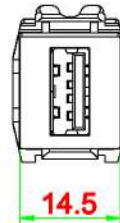
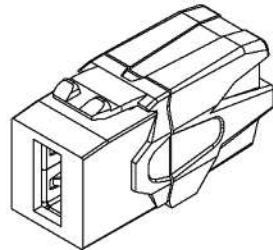
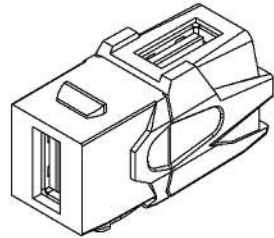

Materials:

Housing : High-impact Acrylonitrile Butadiene Styrene
(ABS resin), UL 94 V-0 rated

PCB : FR4

USB 2.0 Connector:

Shell : Copper alloy, plated with Nickel

Plastic : High-impact Polybutylene terephthalate
(PBT resin), UL 94 V-0 rated

Contact : Phosphor bronze, plated with hard gold over nickel
underplate on contact area, plated with tin over nickel
underplate on solder area

TOLERANCE: X ± 1 · X ± 0.2 · XX ± 0.15